

NTC thermistor temperature to network Modbus TCP and MQTT data acquisition module WJ186

Product features:

- Convert resistors such as NTC10K/NTC20K to standard Modbus TCP protocol
- Supports communication protocols such as TCP Server, UDP, MQTT, etc
- Built in web page function, data can be queried through web pages
- Wide power supply range: 8~32VDC
- High reliability, easy programming, and easy application
- Standard DIN35 rail installation, convenient for centralized wiring
- Users can set module IP addresses and other parameters on the webpage
- Low cost, small size, modular design
- Dimensions: 106 mm x 59mm x 37mm

Typical applications:

- Signal measurement, monitoring, and MQTT reporting
- TCP network, data collection
- Intelligent building control, security engineering and other application systems
- Industrial automation control system
- Industrial site signal isolation and long-distance transmission
- Equipment operation monitoring, MES system
- Measurement of sensor signals
- Acquisition and recording of industrial field data
- Development of medical and industrial control products
- Measurement of temperature signals such as NTC10K/NTC20K

Product Overview:

The WJ186 product is an IoT and industrial Ethernet acquisition module that enables transparent data exchange between sensors and networks. The analog data from sensors can be forwarded to the network.



WJ186

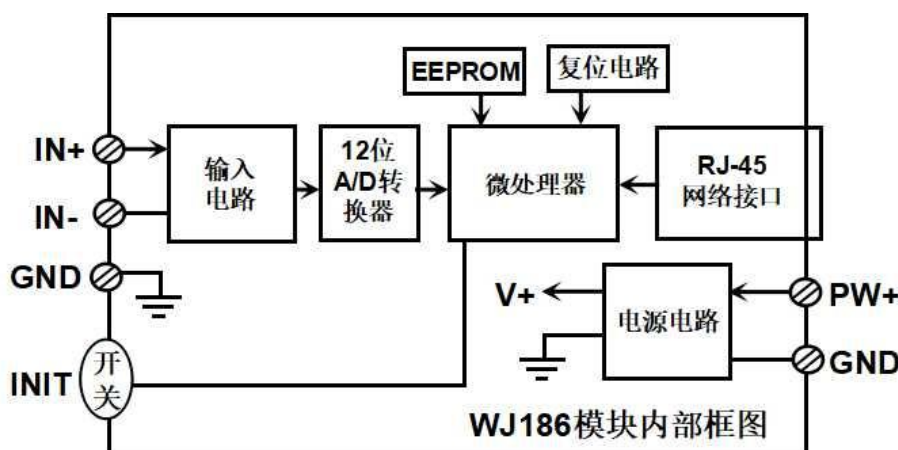

Figure 2 Internal Block Diagram of WJ186 Module

The WJ186 series products include power conditioning, NTC10K/NTC20K resistance signal acquisition, and RJ-45 network interface communication. The communication method adopts MODBUS TCP protocol. TCP is a transport layer based protocol that is widely used and a reliable connection oriented protocol. Users can directly set module IP addresses, subnet masks, etc. on the webpage. Can be used for monitoring and controlling the operation of sensor devices.

The WJ186 series products are intelligent monitoring and control systems based on microcontrollers, where user set module IP addresses, subnet masks, and other configuration information are stored in non-volatile memory EEPROM.

The WJ186 series products are designed and manufactured according to industrial standards, with strong anti-interference ability and high reliability. The working temperature range is -45 °C to +80 °C.

Function Introduction:

The WJ186 remote I/O module can be used to measure 1 channel of temperature signals such as NTC10K/NTC20K.

1. Temperature signal input

12 bit acquisition accuracy, 1 NTC temperature signal input. All signal input ranges have been calibrated before the product leaves the factory. During use, users can also easily program and calibrate themselves.

2. Communication Protocol

Communication interface: RJ-45 network interface. The two indicator lights at the network port position, the Link light (green light) stays on and the Data light (yellow light) stays on after the network cable is plugged in.

Communication protocol: MODBUS TCP protocol is adopted to achieve industrial Ethernet data exchange. It can also communicate with modules through TCP sockets.

Network cache: 2K bytes (for both sending and receiving)

Communication response time: less than 10mS.

3. Anti interference

There is a transient suppression diode inside the module, which can effectively suppress various surge pulses and protect the module.

Product model:

WJ186 - NTC□ - T□ - RJ45

Input type: NTC □		Temperature range: T □		Communication interface: RJ45	
code	explain	code	explain	code	explain
NTC1K	NTC1K type thermistor	T1	-20-100°C	RJ45	Output as RJ-45 network interface
NTC5K	NTC5K type thermistor	T2	0-100°C		
NTC10K	NTC10K type thermistor	T3	0-150°C		
NTC20K	NTC20K type thermistor	T4	0-200°C		
NTC50K	NTC50K type thermistor	T5	0-400°C		
NTC100K	NTC100K type thermistor	Tu	User defined		

Selection Example 1: Model: **WJ186-NTC10K-T1-RJ45** represents one **NTC10K**, -20~100 °C signal input, and the output is an RJ-45 network interface

Selection Example 2: Model: **WJ186-NTTC100K-T2-RJ45** represents 1 channel **NTC100K**, 0~100 °C signal input, and output as RJ-45 network interface

WJ186 General Parameters:

(Typical @+25 °C, Vs is 24VDC)

Input type: NTC resistor input

Accuracy: 0.1%

Temperature drift: ± 50 ppm/°C (± 100 ppm/°C, maximum)

Bandwidth: -3 dB 10 Hz

Conversion rate: 4Sps (factory default value, users can modify the conversion rate on the webpage.)

You can set the AD conversion rate to 2SPS, 4SPS, 8SPS, 16SPS, 32SPS, 50SPS, 80SPS, 100SPS by sending commands

Common mode rejection (CMR): 120 dB (1k Ω Source Imbalance @ 50/60 Hz)

Normal mode suppression (NMR): 60 dB (1k Ω Source Imbalance @ 50/60 Hz)

Input protection: overvoltage protection, overcurrent protection

Communication: MODBUS TCP communication protocol or TCP socket character protocol or MQTT protocol

Web page: Supports web access module and web page setting module parameters.

Interface: RJ-45 network interface.

Communication response time: 100 ms maximum

Working power supply: +8~32VDC wide power supply range, with internal anti reverse and overvoltage protection circuits

Power consumption: less than 3W

Working temperature: -45~+80 °C

Working humidity: 10~90% (no condensation)

Storage temperature: -45~+80 °C

Storage humidity: 10~95% (no condensation)

Dimensions: 106 mm x 59mm x 37mm

Pin definition and wiring:

Pin	name	Description	Pin	name	Description
one (Switch)	INIT	Enter AP configuration mode switch	three	GND	Negative terminal of power supply, signal common ground
			four	PW+	Positive end of power supply
two (Internal port)	RJ-45	RJ-45 network interface	five	GND	Signal public area
			six	IN-	Analog signal input negative terminal
			seven	IN+	Analog signal input positive terminal

Note: The pins with the same name are internally connected

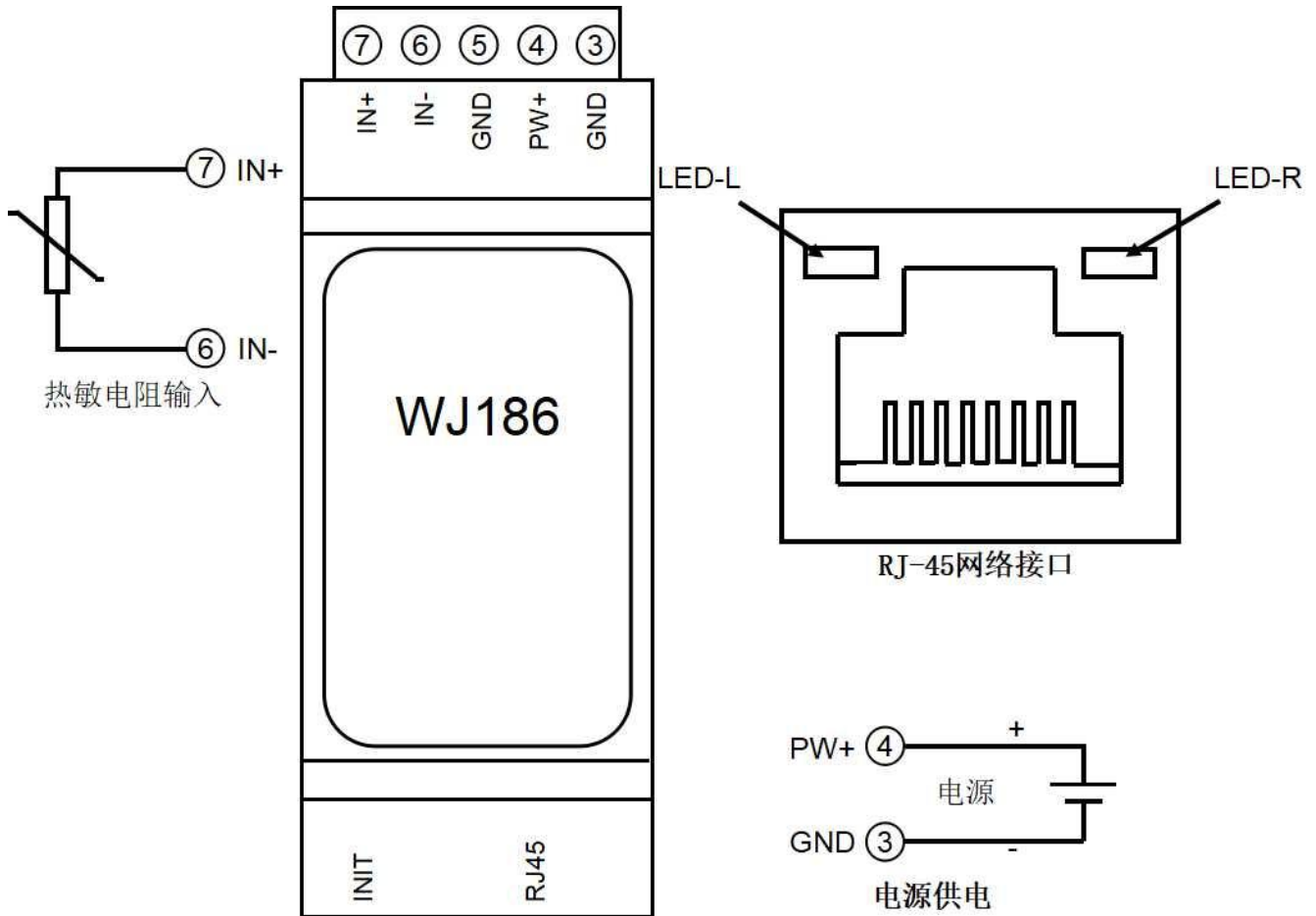
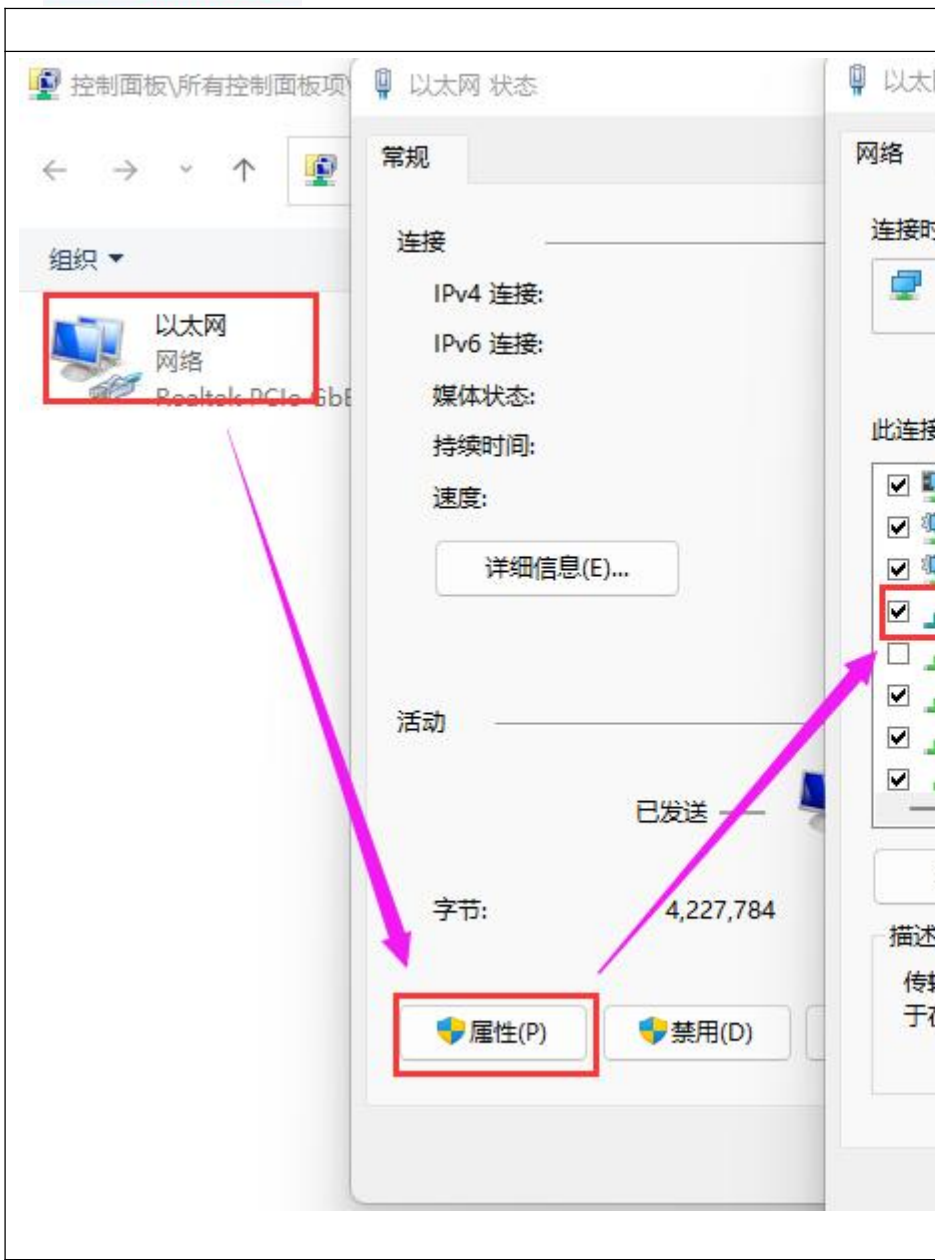



Figure 3 Wiring diagram of WJ186 module
Configure WJ186 module through computer

网线连接

- 1、 Connect the module directly to the computer via Ethernet cable and provide power to the module.

	<p>2、 Open the computer "Ethernet" - "Properties" - "Internet Protocol Version 4 (TCP/IPv4)" - Set the computer IP and other information as follows:</p> <p>“ IP address: 192 168 . 0 eight Subnet mask: 255 255 . 255 . 0 Default gateway: 192 168 . 0 one ”</p>
	<p>3. Open a browser to access: "192.168.0.7"</p>

<div style="border: 1px solid black; padding: 5px;"> <h3>参数设置</h3> <p>采样速率 16 SPS</p> <hr/> <h3>网络配置</h3> <p>工作方式 TCP Server</p> <p>本地IP设置 手动设置IP</p> <p>MAC地址 94:05:B1:A1:F7:CD</p> <p>IP地址 192.168.0.7</p> <p>默认网关 192.168.0.1</p> <p>子网掩码 255.255.255.0</p> <p>本地端口 23</p> <p>自动上报时间间隔(ms) 0</p> <p>模块名称 945B1A1F7CD</p> <p>MQTT设置 关闭MQTT功能</p> <p style="text-align: center; background-color: #007bff; color: white; padding: 5px; margin-top: 10px;">保存并重启</p> <p style="font-size: small; margin-top: 5px;">Mac地址:94:05:B1:A1:F7:CD; 版本:1.0</p> </div>	<p>Click on 'Configure Module Parameters' to set module parameters, as shown in the figure</p>
<div style="border: 1px solid black; padding: 5px;"> <h3>数据显示</h3> <div style="border: 1px solid black; padding: 5px; margin-top: 10px;"> <h4>温度值</h4> <p>通道0:-888.888855°C</p> </div> </div>	<p>Click on 'View Data Online' to view module data, as shown in the figure</p>

Character Communication Protocol:

MQTT protocol: After a successful connection, a command is sent to the [MQTT subscription topic](#) of the module, and the replied data is displayed on the [MQTT publication topic](#) of the module.

Under working modes such as **TCP Server, TCP Client, UDP Mode, Web Socket, etc.:** After a successful connection, commands can be sent and data can be received.

(1) Read data command

Send: # 01 (If timed automatic reporting is set, there is no need to send commands, the module will report data at regular intervals)

Reply: {"devName": "76B659F32335", "time": 7811329, "temp": 125000000}

Format Description:

The module name 'devName' can be modified on the webpage as needed

The internal time of the 'time' module, measured in mS.

The temperature data collected by the "temp" module is in °C.

You can also read a single set of data:

#01>temp **reply:** {"temp": [125000000]}

2. Read configuration commands

The configuration parameters of the reading module can also be viewed directly on the webpage.

Send:% 01ReadConfig

Reply: {"version": "V1.0", "dataRate": 3, "setIP": 1, "mac": "76: B6:59: F3:23:35", "ipAddress": "192.168.0.7", "gateway": "192.168.0.1", "netmask": "255.255.255.0", "work mode": 0, "localPort": 23, "remotePort": 23, "remoteServerIP": "192.168.0.160", "sendTime": 0, "devName": "76B659F32335", "setMQTT": 0, "mqttHostURL": broker.emqx.io, " contentId ":" 76B659F32335 ", " username ":" ", " passwd ":" ", " topic ":" /wayjun/sub ", " port ":" 1883," pubTime ": 5000," subtopic ":" /wayjun/sub "}

3. Set configuration commands

The configuration parameters of the module can also be set directly on the webpage. You can set all or some parameters, and the module will automatically restart after setting.

send out:

%01WriteConfig {"version":"V1.0","dataRate":3,"setIP":1,"mac":"76:B6:59:F3:23:35","ipAddress":"192.168.0.7","gateway":"192.168.0.1","netmask":"255.255.255.0","workmode":0,"localPort":23,"remotePort":23,"remoteServerIp":"192.168.0.160","sendTime":0,"devName":"76B659F32335","setMQTT":0,"mqttHostUrl":"broker.emqx.io","clientId":"76B659F32335","username":"","passwd":"","topic":"/wayjun/pub","port":1883,"pubTime":5000,"subtopic":"/wayjun/sub"}

You can also set only a single parameter, such as modifying IP:% 01WriteConfig {"ipAddress": "192.168.0.7"}

Reply:! 01 (cr) indicates successful setting? 01 (cr) indicates a command error

Modbus TCP protocol

The module defaults to one Modbus TCP Server at the factory, no need to set it up, just communicate according to the Modbus TCP protocol. If more Modbus TCP servers are needed, please change the module's working mode to Modbus TCP in the configuration parameters. Supports up to 6 Modbus TCP servers.

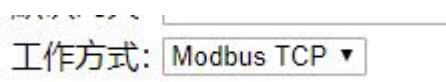

(1) Modbus TCP data frames:

Transmission over TCP/IP Ethernet, supporting Ethernet II and 802.3 frame formats. As shown in Figure 3, the Modbus TCP data frame consists of three parts: packet header, function code, and data.

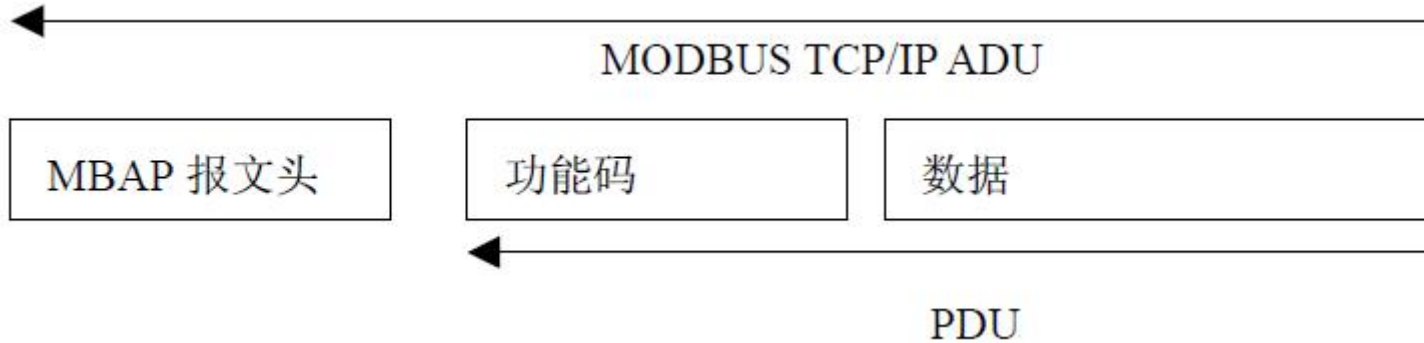

Figure 6: Request/Response of MODBUS on TCP/IP

(2) MBAP message header description:

The MBAP header (MBAP, Modbus Application Protocol, Modbus Application Protocol) is divided into 4 fields, totaling 7 bytes, as shown in Table 1.

Table 1: MBAP Message Header

Domain	Length (B)	Description
Transmission identification	2 bytes	Indicate the transmission of a MODBUS query/response
Protocol Logo	2 bytes	0=MODBUS protocol
Length	2 bytes	Subsequent byte count
Unit identifier	1 byte	Identification code of remote slave station connected on serial link or other bus

(3) Modbus function code:

Modbus function codes are divided into three types, namely:

- (1) Public Function Code: Defined function codes that ensure their uniqueness and are recognized by Modbus.org;
- (2) There are two sets of user-defined function codes, namely 65-72 and 100-110, which do not require approval but do not guarantee the uniqueness of code usage. If it becomes public code, it needs to be approved by RFC;
- (3) The reserved functional code, which is used by certain companies on certain traditional devices, cannot be used for public purposes.

Among the commonly used public function codes, WJ89 supports some function codes, as shown below:

Function code	name	explain
03	Read Holding Register	Read and hold register 1 represents high level, 0 represents low level.

(4) Description of supported function codes

03 (0x03) Read hold register

In a remote device, use this function code to read the contents of consecutive blocks in the hold register. The request PDU specifies the starting register address and the number of registers. Address registers from scratch.

Therefore, addressing registers 1-16 are 0-15. In the response message, each register has two bytes, with the first byte being the data high bit and the second byte being the data low bit.

Example of function code 03, read input analog quantity, register address 40001:

request			response		
Field Name		hexadecimal	Field Name		hexadecimal
MBAP message header	Transmission identification	01	MBAP message header	Transmission identification	01
		00			00
	Protocol Logo	00		Protocol Logo	00
		00			
	length	00		length	00
		06			05
Unit identifier	01	Unit identifier	01		
Function code		03	Function code		03
Starting address Hi		00	Byte count		02
Starting address Lo		00	Register value Hi (0x00)		00
Register number Hi		00	Register value Lo (DI7-DI0)		00
Register number Lo		01			

Register address description for WJ186 (note: addresses are all decimal numbers)

Supports registers with function code 03.

Address 4X (PLC)	Address (PC, DCS)	Data content	attribute	Data Explanation
forty thousand and one	0	Integer temperature value	read-only	The measured temperature data, signed integer, divided by 10 equals the actual temperature. If the data is -8888, it indicates that the thermistor is disconnected, If the data is 8888, it indicates a short circuit in the thermistor.
40003~40004	2~3	Floating point temperature value	read-only	Measured temperature data, 32-bit floating-point number, The lower 16 bits are in register 40031, The high 16 bits are in register 40032 If the data is -888.88, it indicates that the thermistor is disconnected, If the data is 888.88, it indicates a short circuit in the thermistor.
forty thousand	two hundred and	Module Name	read-o	High bit: 0x01 Low bit: 0x86

two hundred and eleven	ten		nly	
------------------------	-----	--	-----	--

Common problems with WJ186

1. Cross network segment issues

If the IP of the device and the communicating PC are not in the same network segment and are directly connected via Ethernet or under the same sub router, then the two cannot communicate at all.

give an example:

Device IP: 192.168.0.7

Subnet mask: 255.255.255.0

PC's IP: 192.168.1.100

Subnet mask: 255.255.255.0

Due to the device's IP being 192.168.0.7, it is unable to log in to the device's webpage or ping it on the PC.

If you want the two to communicate, you need to set the subnet mask of the device and PC, as well as the subnet mask on the router, to 255.255.0.0, so that you can log in to the module webpage.

2. The device can ping, but the webpage cannot be opened

There may be several reasons for this:

- 1) The device has set a static IP address that conflicts with the IP addresses of existing devices in the network
- 2) The HTTP server port has been modified (default should be 80)
- 3) Other reasons

Solution: Reset the device to an unused IP address; Restore factory settings or enter the correct port when opening the browser.

3. Every once in a while, there is a disconnection and reconnection

Every once in a while, there will be a phenomenon of disconnection and reconnection

Reason: There is an issue of IP address conflict between the serial server and other devices

4. Communication is abnormal, network connection cannot be established, or search cannot be found

The firewall of the current computer needs to be turned off (in the Windows firewall settings)

Three local ports must not conflict, meaning they must be set to different values. Default values are 23, 26, and 29

Having illegal MAC addresses, such as full FF MAC addresses, may result in inability to connect to the target IP address or duplicate MAC addresses.

Illegal IP addresses, such as network segments that are not in the same network segment as the router, may not be able to access the external network.

5. Hardware problem search

Poor power supply from the power adapter or poor contact of the plug

If the power light and network port light are not on, it means there is no power supply or the hardware is broken

Dimensions: (Unit: mm)

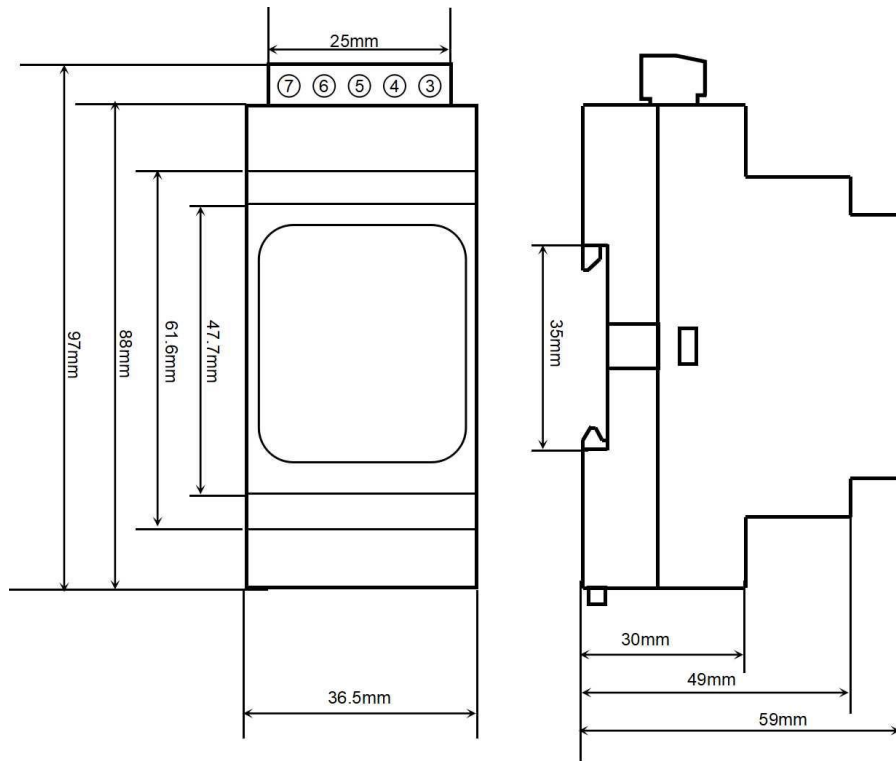

Can be installed on standard DIN35 rails

guarantee:

Within two years from the date of sale, if the user complies with the storage, transportation, and usage requirements and the product quality is lower than the technical specifications, it can be returned to the factory for free repair. If damage is caused due to violation of operating regulations and requirements, device fees and maintenance fees shall be paid.

Copyright:

Copyright © 2024 Shenzhen Weijunrui Technology Co., Ltd.

Without permission, no part of this manual may be copied, distributed, translated, or transmitted. This manual is subject to modification and update without prior notice.

Trademark:

The other trademarks and copyrights mentioned in this manual belong to their respective owners.

Version number: V1.0

Date: February 2024